

Data Sheet



Article number: 204060M16125A0UK

Description: E+G levelling foot
GN 40-60-M16-125-A0-UK

Note: UK With nut, Hexagon socket at the top, Wrench flat at the bottom

Measures

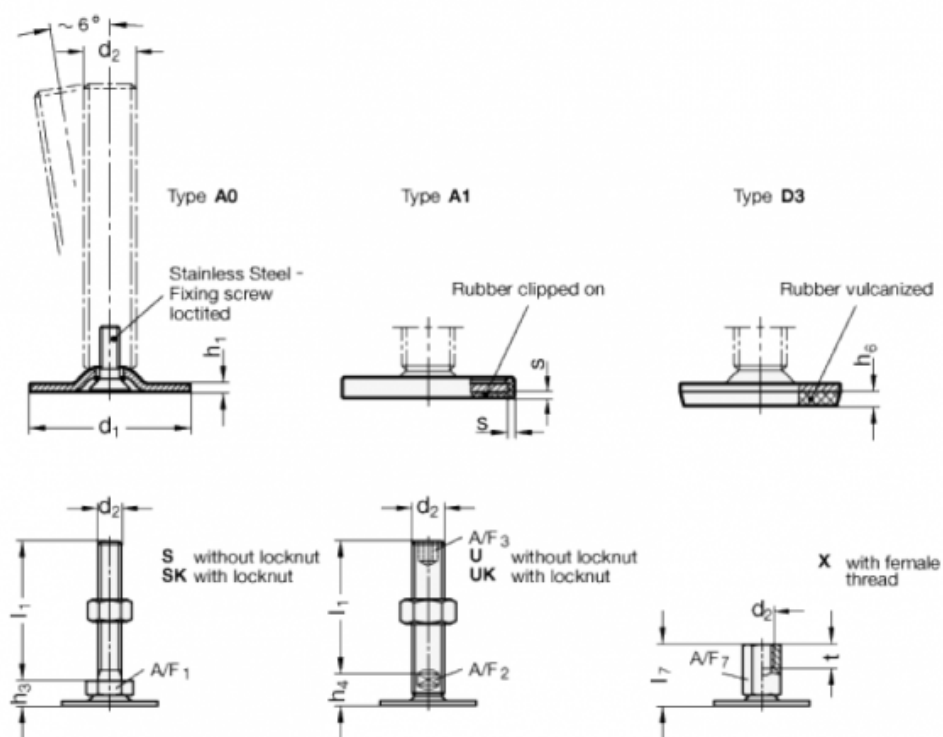

A/F2 = 12
A/F3 = 8
d1 = 60
d2 = M16
h1 = 2.5
h4 = 17
h6 =
l1 = 125

s =